

# DZDT451 Cell Phone Detector



A Wall-Mount Device

## DZDT451 Cell Phone Detector

### Features:

- 1. Up to 8 Bands Detection**
- 2. Band Sensitivity individually adjustable**
- 3. Sensitivity can be set to <math><1\text{dB}</math> above band noise floor**
- 2. Simultaneously detect all bands**
- 3. Catch Short Message Transmission**
- 4. Detect Cell Phone Signal Only**
- 5. Immune to DECT & WiFi Interference**
- 6. Option with**
  - Built-In Message Recorder and Play Back PA speaker**
  - N.O. Contact for remote Siren and Strobe Light**
  - 5V signal to turn On-Off Jammer nearby**
  - TCP/IP for remote centralized control and event recording**
  - Wireless Siren & Strobe control upon special order**
- 7. Wall mount system run continuously by AC power**



## Product Codes

**DZDT451-VX-BX-R-C-JX-IX**

**VX**

1: 110VAC  
2: 220VAC

**BX**

0: Strobe Light Only  
1: Strobe Light + Beeper

**R**

Recorder+PA Speaker

**CX**

1: N.O. Contact  
240VAC, 5A  
2: Plus Siren Box  
3: **Wireless**  
**(Custom Item)**

**JX**

0: 5V TTL  
1: N.O. Contact  
240VAC, 5A

**T**

TCP/IP + Software

## Reference Applications:

Recommended Option Combinations are shown in the following slides

# Cell Phone Wall-Mount Detector Application – Basic

Product Code: **DZDT451-V1-B1**

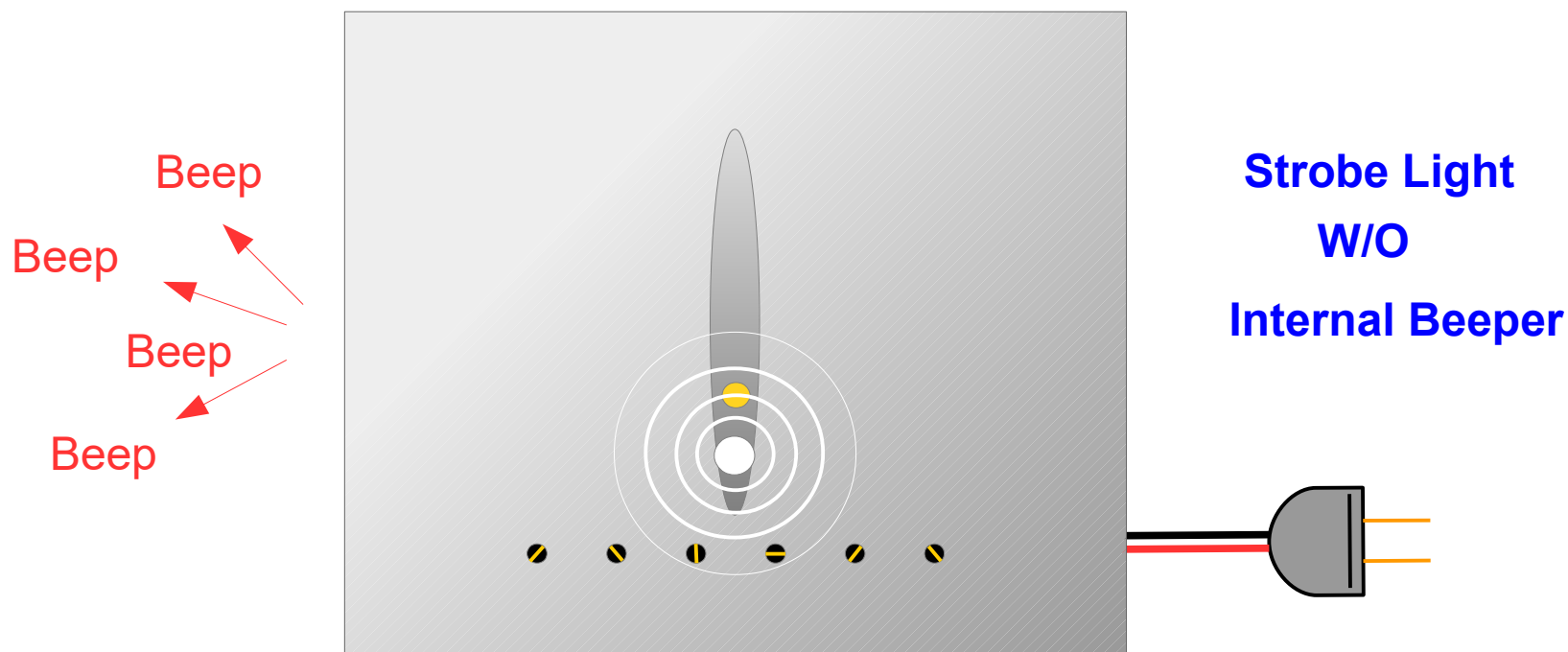

# Cell Phone Wall-Mount Detector Application – Stand Alone

Product Code: **DZDT451-V2-B0-R**

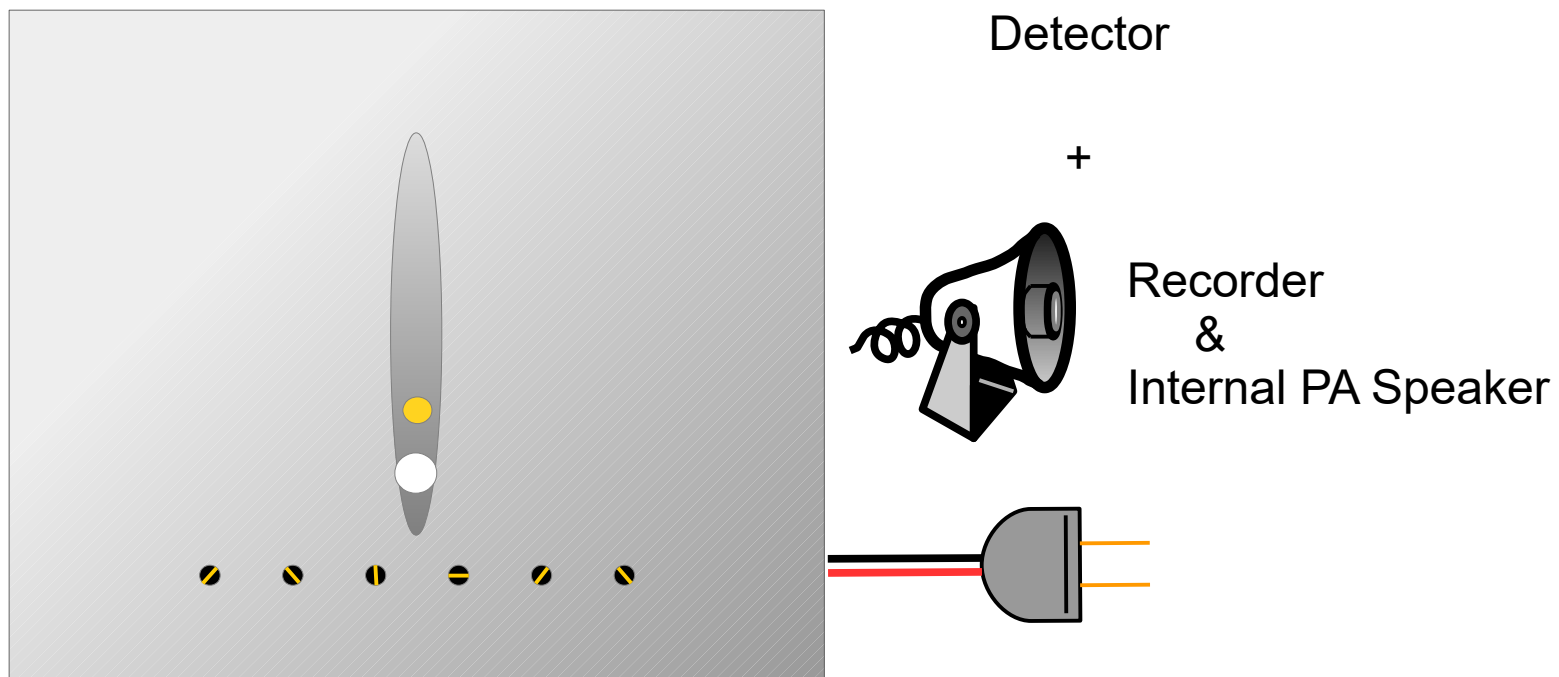

16 to 40 seconds message recording and played back upon signal detection

# Cell Phone Wall-Mount Detector Applications – Remote Control

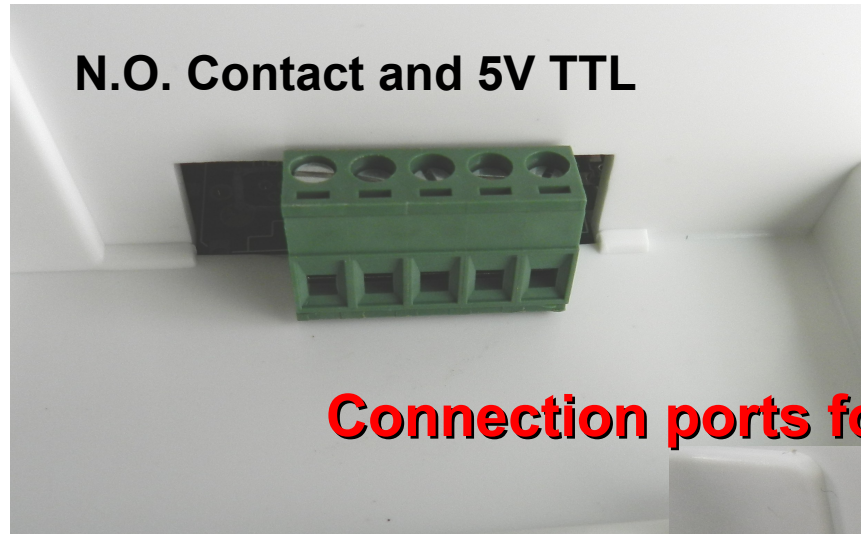

**Connection ports for different applications**

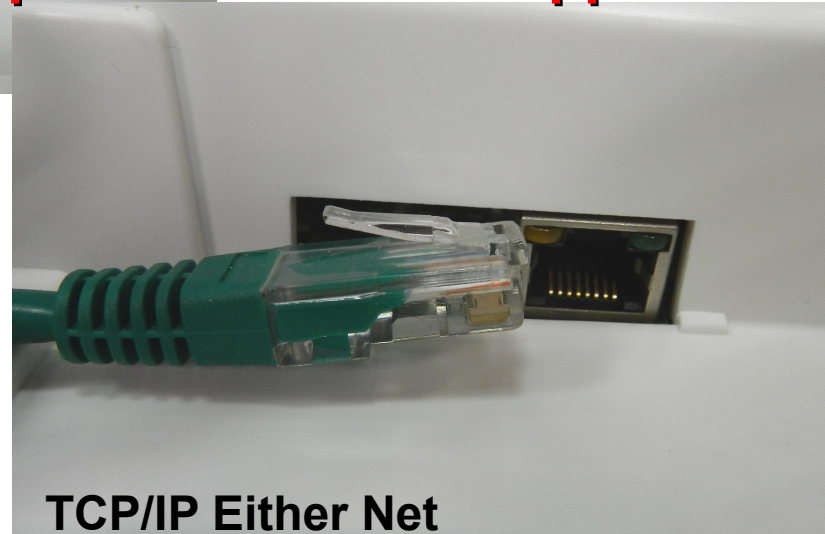

# Cell Phone Wall-Mount Detector Application – Remote Alarm

Product Code: **DZDT451-V2-B0-C2**

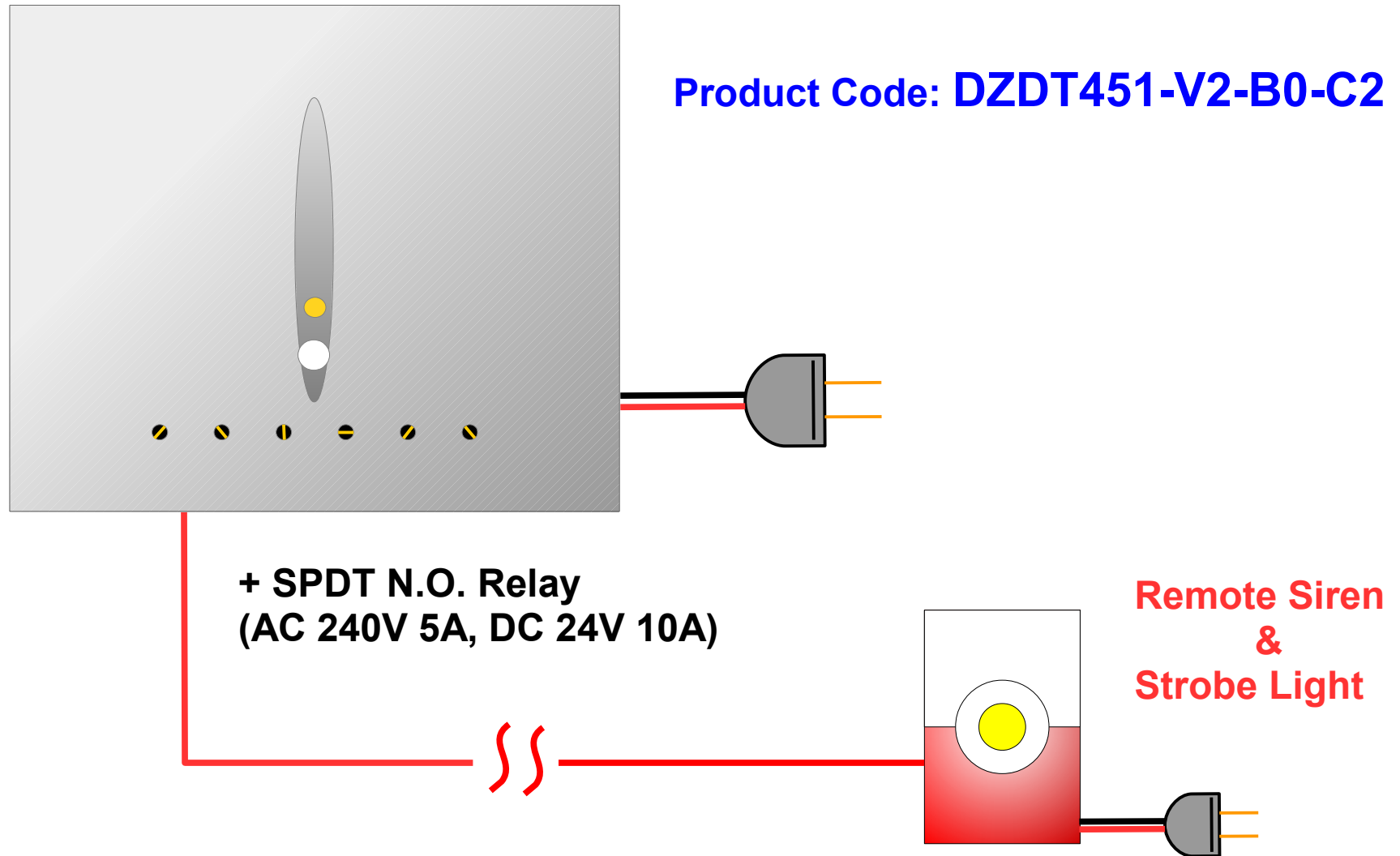

# Cell Phone Wall-Mount Detector Application – Wireless Alarm



Product Code: **DZDT451-V2-B0-C3**

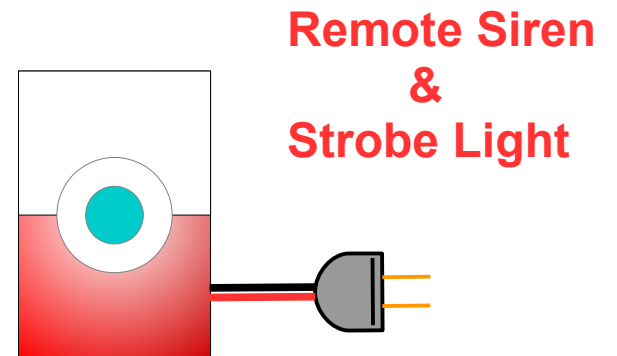

Remote Siren  
&  
Strobe Light

**\*Special Order Only**

# Cell Phone Wall-Mount Detector Application - Jamming Control

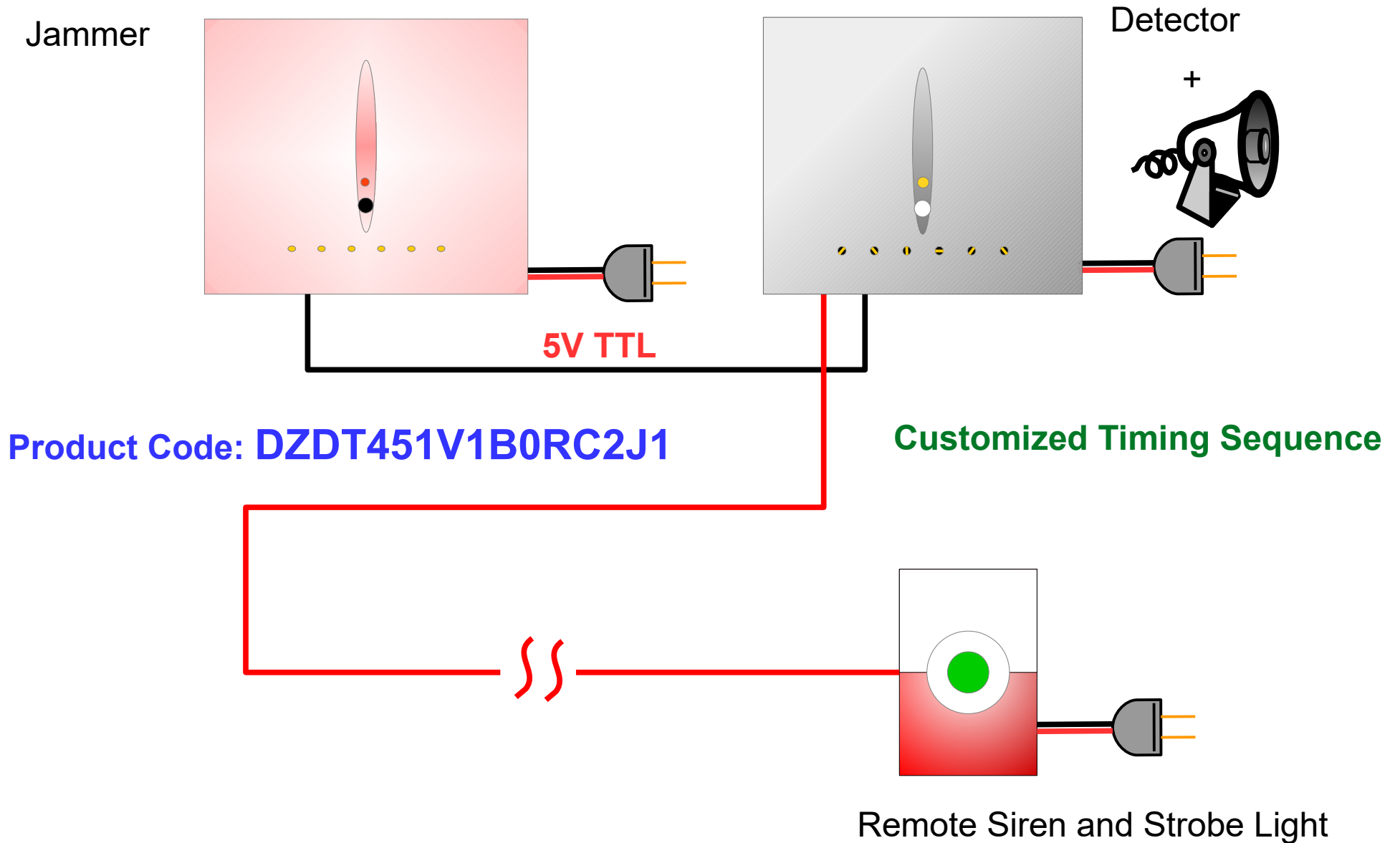

# Cell Phone Wall-Mount Detector Application - TCP/IP

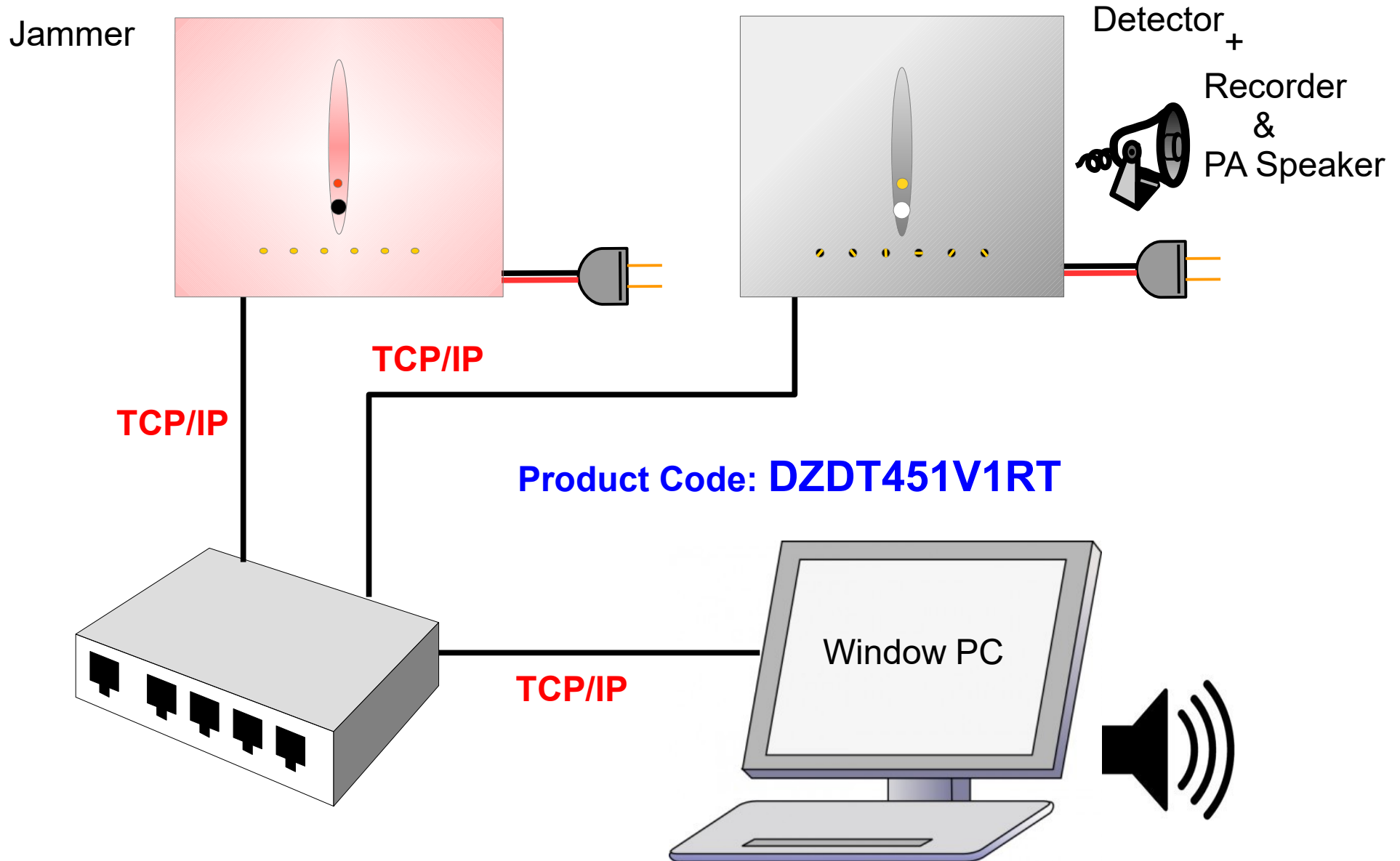

# Software for TCP/TP remote monitoring

## Set Up Page

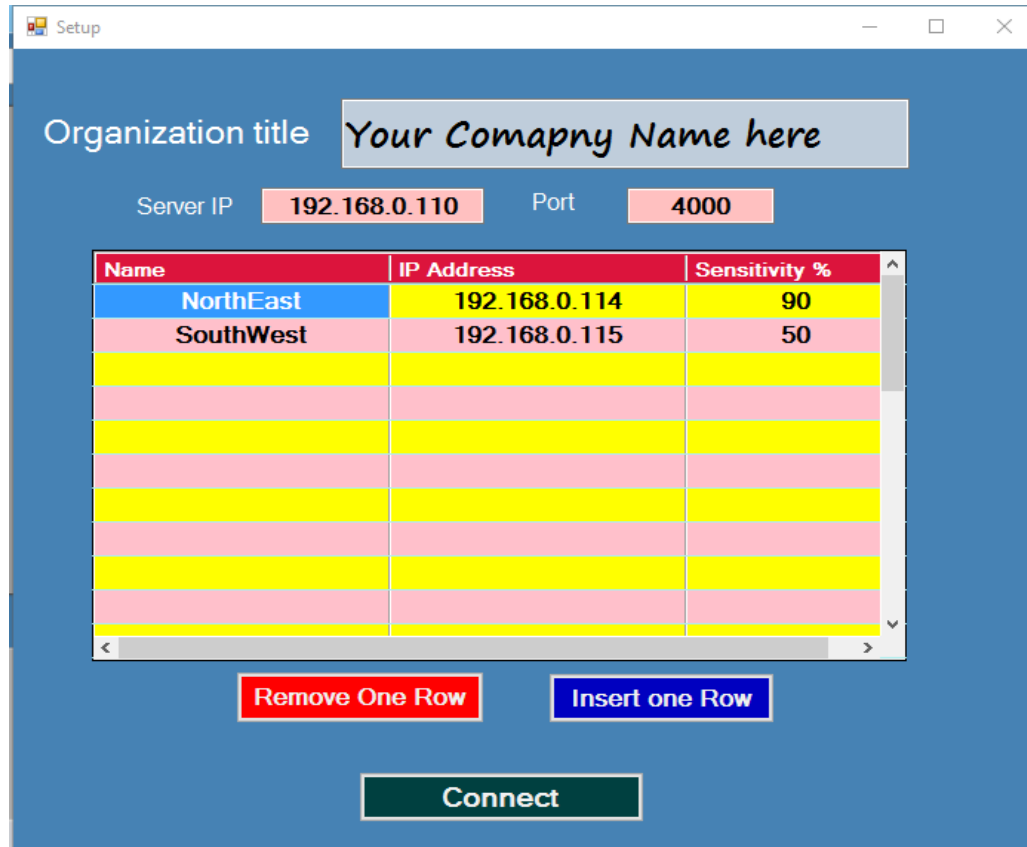

Organization title

Server IP  Port

Name	IP Address	Sensitivity %
NorthEast	192.168.0.114	90
SouthWest	192.168.0.115	50

User enters

Organization Name

Server IP and Port

Detector location

Detector IP

Desire Sensitivity



# DZDT451 Cell Phone Detector

## Specification (Standard):

Detection Bands		Comment	
700	703 – 733 MHz	FDD Up Link	*
800	791 – 821 MHz	FDD Up Link	*
900	880 – 915 MHz	FDD Up Link	*
1800	1710 – 1785 MHz	FDD Up Link	*
2100	1920 – 1980 MHz	FDD Up Link	*
2600	2500 – 2620 MHz	FDD Up Link + TDD	*
Sensitivity	User Adjustable	> -75 dBm	Maximum is 1 dB above band noise floor
Dynamic Range	> 35 dB		
Isolation	> 30 dB	900 band is 25 dB	

\* China, US, Canada, West South America need special request

# DZDT451 Cell Phone Detector

## Specification (Standard): Page 2

		Comment	
Antenna	Inverted F multi-band	Omni - Directional	Horizontal Gain > 3 dB
Detection Mode	Peak Detection	Parallel Detection	
Sensitivity Tuning	Individual Set Screw	10 turns	Increase: Clockwise
Response Time	< 1 mini-second	Catch all short messaging	All band Simultaneous
Alarm Mode	Standard	Options	
	Strobe Light & Beeper	Internal Recorder & PA	Ports for remote system
Relay Contact	5A/240VAC, 10A/28VDC	SPDT Normally Open	10A/110VAC
Power Supply	80 – 240 VAC	No External Adapter	
Dimension	27 cm x 24 cm x 7 cm	Vertical Wall mount	
Weight	1.1 Kg		
Warranty	1 year		